

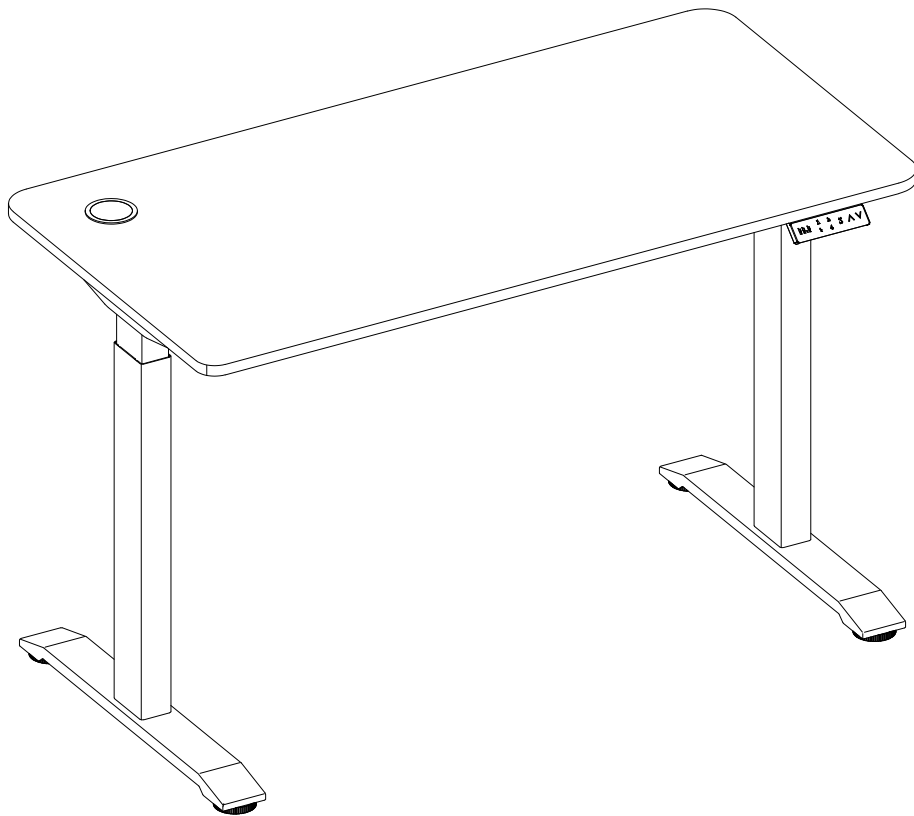





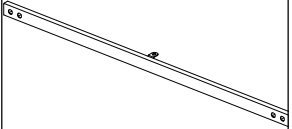

Montagehandleiding Installation instruction Installationsanleitung

Model: E-balance 117

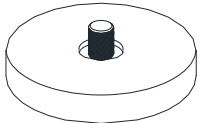
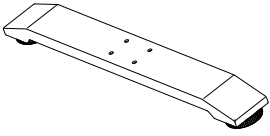

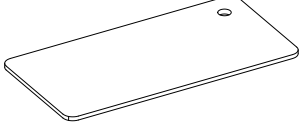
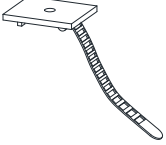
Packing List:

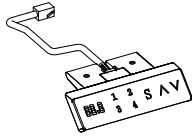
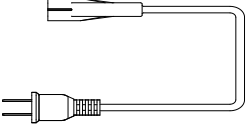
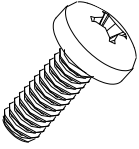
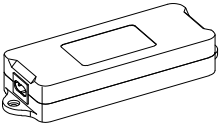
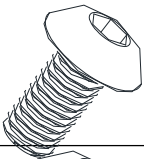
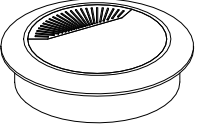
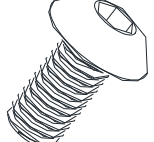
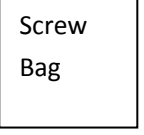
A	Column Tafelpoot Tischbein (motor)		1pc	J	Cross Bar Dwarsbalk Querlatte		1pcs
B	Column Tafelpoot Tischbein (no motor)		1pc	K	Adjustusting caps Verstellbare Kappen Steldoppen		4pcs
C	Table Foot Tafelvoet Tischfuß		2pcs	L	Screw ST4*16 Standby / Extra		5pcs
D	Tabletop Bureaublad Tischplatte (optional)		1pc	M	Ribbon/wrap tie Kabelbinder		5pcs
E	Connection Bar Verbindingsstang Pleuelstange		1pc	N	4mm Hex Inbus		1pc
F	Handcontroller		1pc	O	Power Cord Stroomkabel Netzkabel		1pc
G	Cross Screw M4*12		4pcs	P	Control Box		1pc
H	Screw M6*12		17pcs	Q	Wire through Kabelgoot Kabekrinne Plastic		1pc
I	Screw M6*16		8pcs	R	Standby Screw Bag		1bag

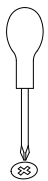

*Crosshead screwdriver required for installation.
Kruiskop schroevendraaier nodig voor installatie.
Für die Installation ist ein Kreuzschlitz schraubendreher erforderlich.*

①

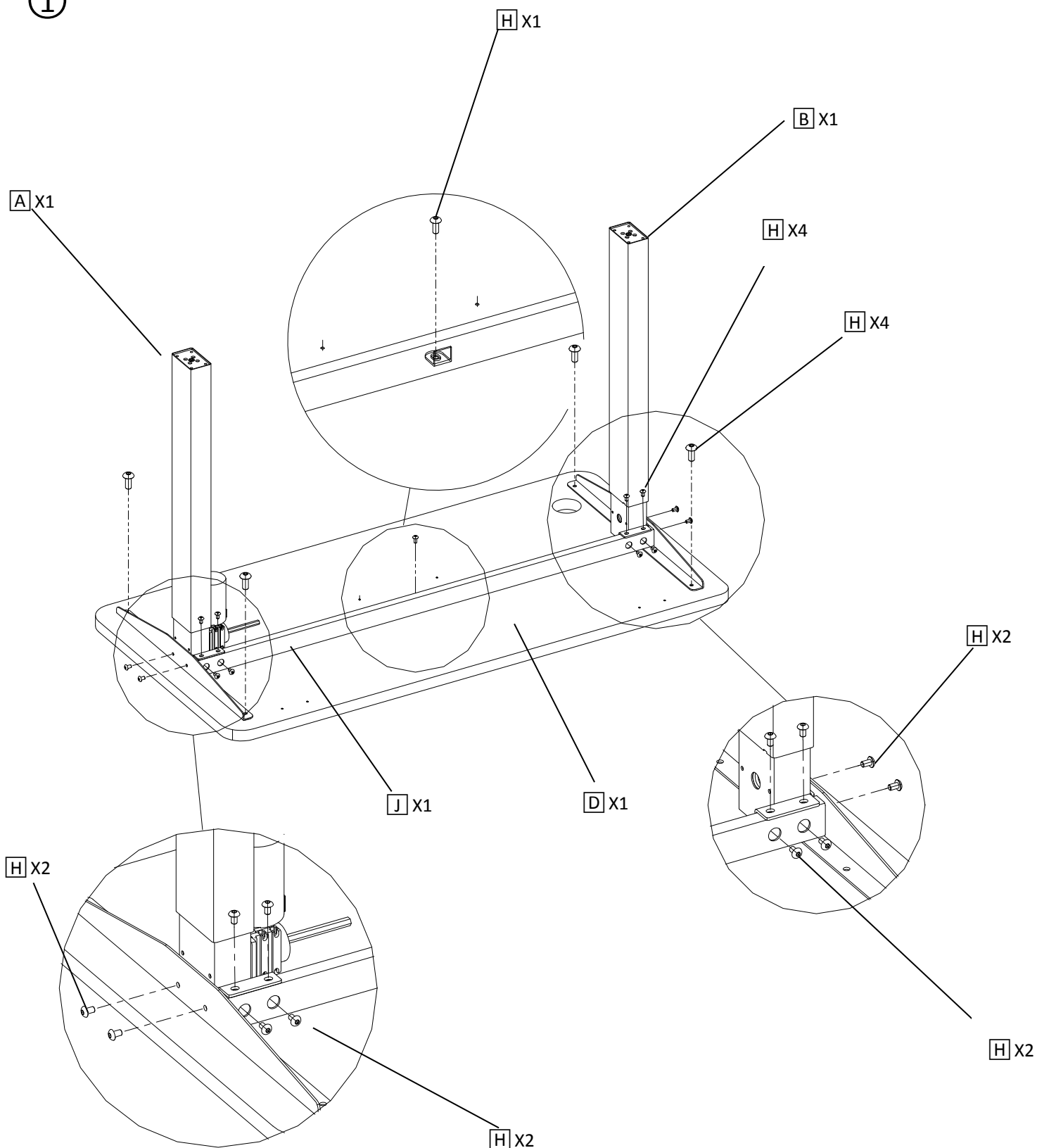

EN: When install the column, screw into 1/3 depth, and then tighten after all the screw are in position.

DE: Wenn Sie das Tischbein installieren, schrauben Sie es auf 1/3 Tiefe und ziehen Sie es fest, nachdem alle Schrauben angebracht sind.

NL: Wanneer u de tafelpoot installeert, schroeft u deze op 1/3 diepte en draait u hem vast nadat alle schroeven op hun plaats zitten.

②

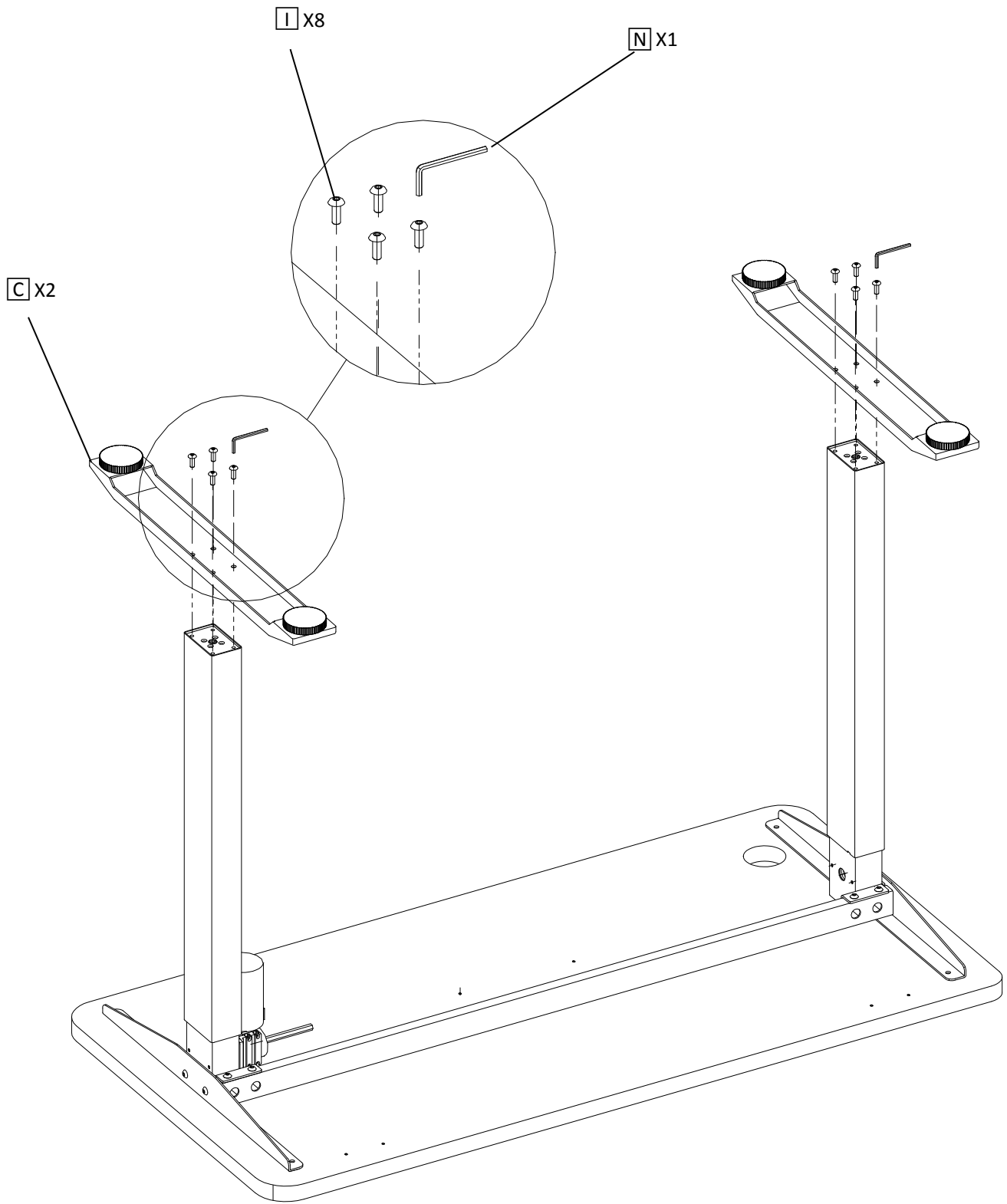

3

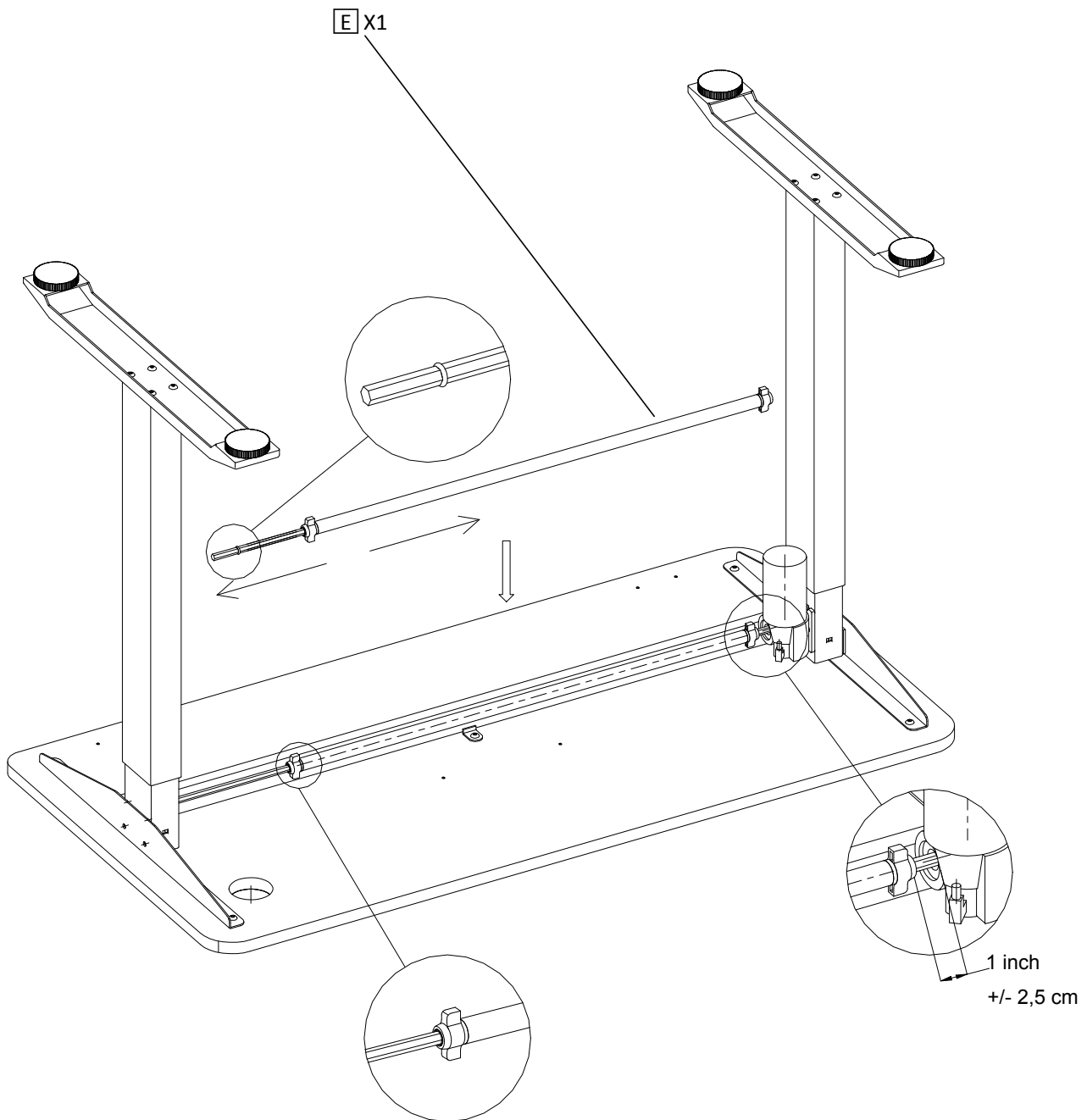

EN: First untighten the plastic caps of the transmission bar (F). Now insert the transmission bar up to the rubber ring in the column (without motor), then transmit the transmission bar with hand to align the other column (with motor). Tighten the plastic caps after installation. Keep about an inch of rod exposed.

DE: Lösen Sie zunächst die Kunststoffkappen der Übertragungsstange etwas (F). Platzieren Sie beim Zusammenbau die Übertragungsstange bis zum Gummiring in die Tischbein (ohne Motor) und stellen Sie die Übertragungsstange von Hand ein, um das andere Tischbein (mit Motor) auszurichten. Lassen Sie etwa 2,5 cm Stange freiliegen.

NL: draai eerst de kunststof doppen van de transmissiestang (F) los. Steek nu de transmissiestang tot aan het rubberen ringetje in de tafelpoot (zonder motor), en stel vervolgens de transmissiestang met de hand om de andere tafelpoot (met motor) uit te lijnen. Draai de kunststof dop aan beide kanten vast na installatie. Houd ongeveer 2,5 cm van de stang zichtbaar.

④

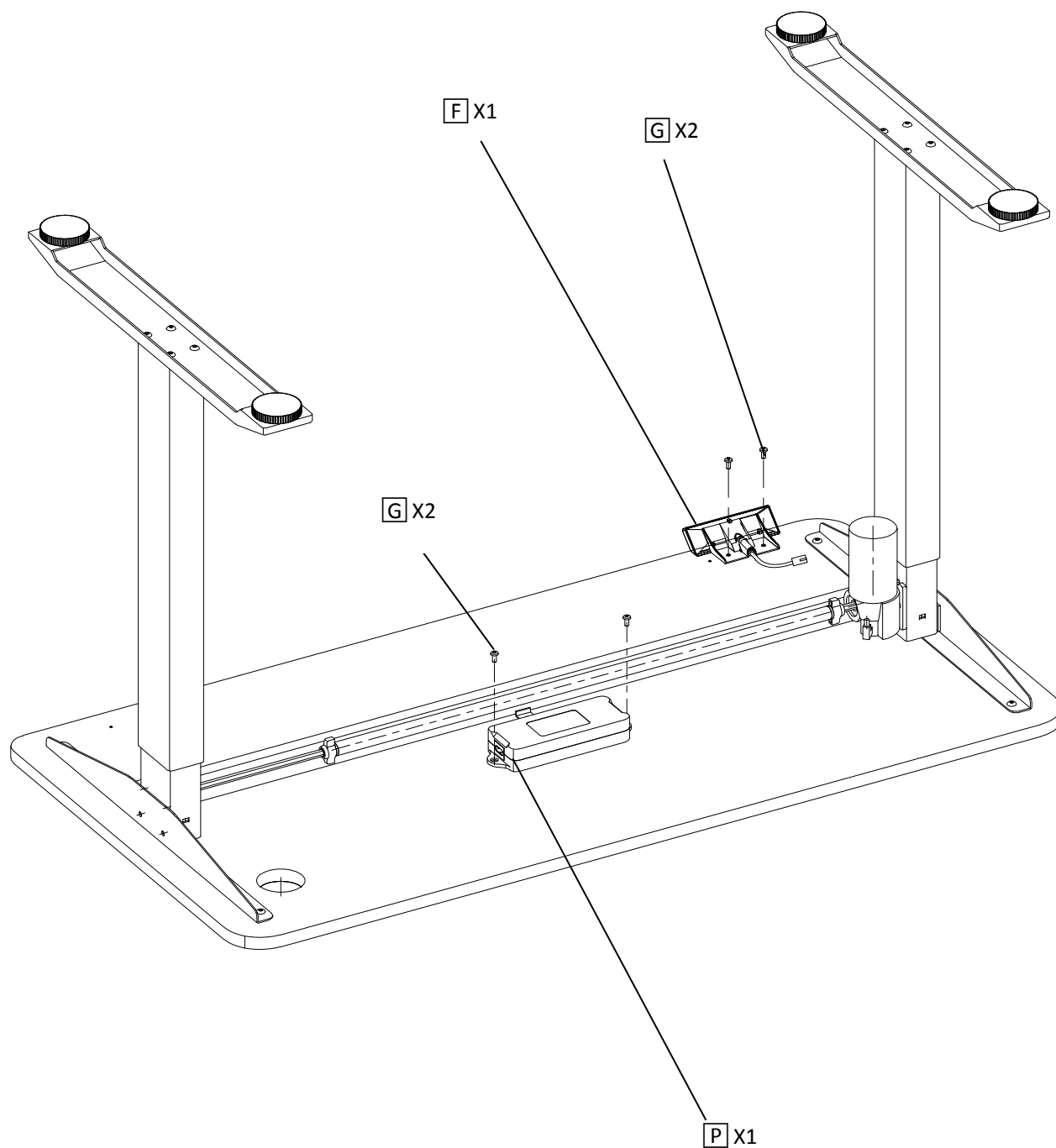

EN: The socket of the control box need to point towards the column with motor so the motor wire can be connected with the control box in the shortest distance .

DE: Der Verbindungspunkt des Control box muss mit dem Motor zum Tischbein zeigen, damit der Stecker in kürzester Entfernung an den Control box angeschlossen werden kann.

NL: Het aansluitpunt van de control box moet gericht zijn naar de tafelpoot met motor zodat de stekker via de kortste afstand met de control box kan worden verbonden.

5

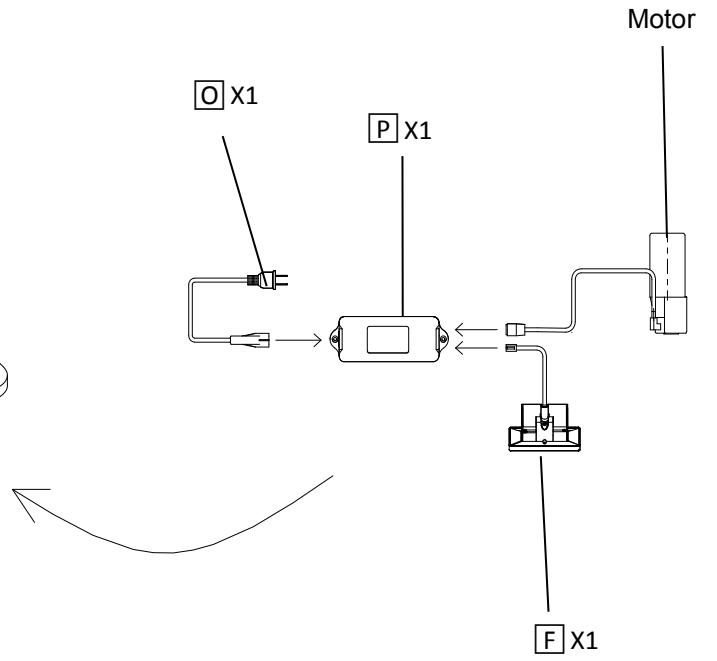
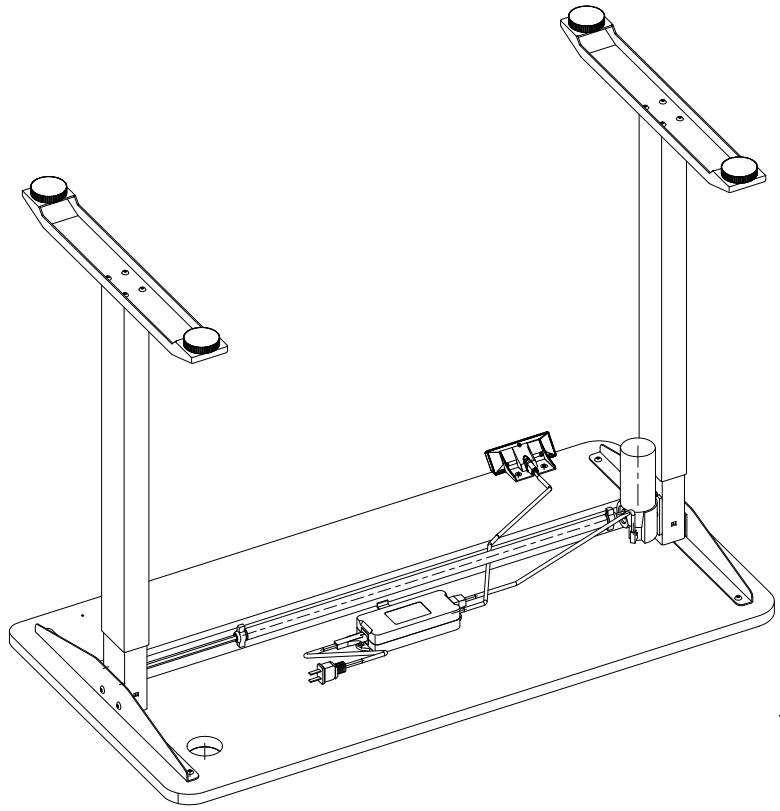

⑥

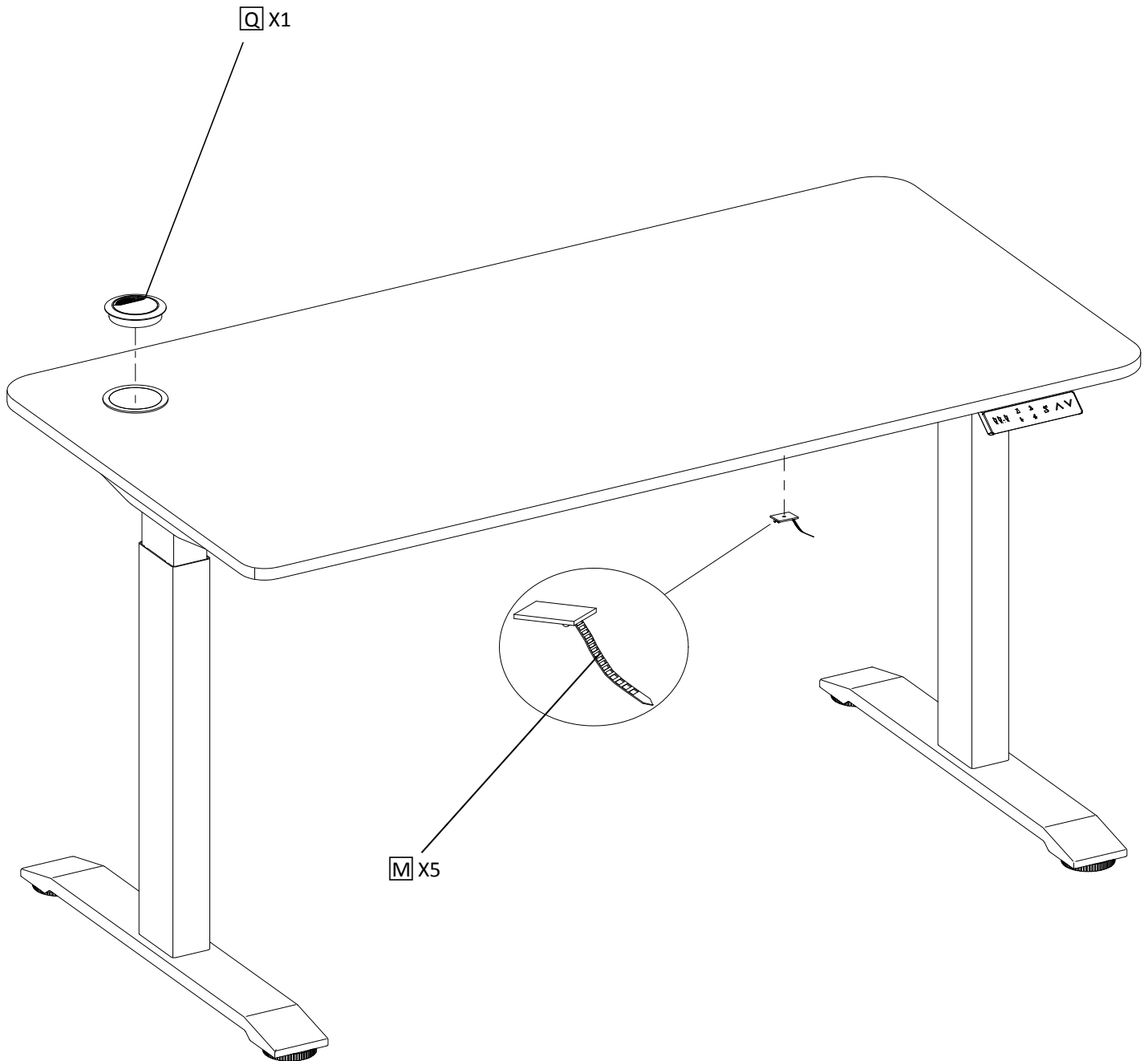

EN: When fixing the wires with tie, be careful to avoid the transmission bar

DE: Vermeiden Sie die Pleuelstange, wenn Sie die Drähte mit dem Kabelbinder sichern.

NL: Pas op dat u de transmissiestang vermijdt wanneer u de draden met de kabelbinder vastzet.

User Manual:

1.Touch button instruction

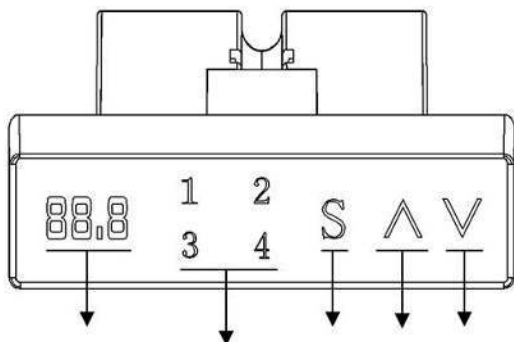

Led display Memory Save UP Down

2. Restart / Herstart

EN: Hold touch down button“∨”, System enter initialization mode, until led display show lowest height.

DE: Halten Sie die Taste “∨” gedrückt, und das System wechselt in den Initialisierungsmodus, bis die LED-Anzeige die Höhe anzeigt.

NL: Houd de toets “∨” ingedrukt, het systeem gaat naar de initialisatiemodus, totdat het led-display de hoogte aangeeft.

3. Position reserve and memory run / Speicherposition einstellen / Geheugenpositie instellen

EN: Touch “S” button , indicator show “S-” , meanwhile “- -” flicker , at the same time touch“1-4”button , reserve this position to relative “1-4”,four memory positions can reserve

DE: Berühren Sie die Taste "S", die Anzeige zeigt "S -" an, während "- -" blinkt, berühren Sie gleichzeitig die Taste 1, 2, 3 oder 4", um diese Höhe zu speichern.

NL: Raak de "S" -knop aan, de indicator toont "S -", ondertussen "- -" flinkt, raak tegelijkertijd de knop 1,2,3 of 4" aan waarop je deze hoogte wilt bewaren.

4. Lock and unlock / Vergrendelen en ontgrendelen / Sperren und Entsperren

EN: Lock : hold touch“S”+ “^” for 5s , indicator show“LOC”, this means system has been locked, can not do any operation.

Unlock : hold touch“S”+ “∨” for 5s , when indicator shows “LOC”change to normal figure, this means system is unlocked.

DE: Sperren: Halten Sie "S" + “^” 5 Sekunden lang gedrückt. Die Anzeige zeigt "LOC" an. Dies bedeutet, dass das System gesperrt ist und keine Operation ausführen kann.

Entsperren: Halten Sie die Taste "S" + “∨” 5 Sekunden lang gedrückt. Wenn die Anzeige "LOC" anzeigt, ändern Sie die Höhe. Dies bedeutet, dass das System entsperrt ist.

NL: Vergrendelen: houd "S" + “^” 5 seconden ingedrukt, de indicator toont "LOC", dit betekent dat het systeem is vergrendeld en geen enkele handeling kan uitvoeren.

Ontgrendelen: houd de toets "S" + “∨” 5 seconden ingedrukt, wanneer de indicator "LOC" aangeeft, wijzig de hoogte, dit betekent dat het systeem is ontgrendeld.

5. Remark / Anmerkung / Opmerking

EN: If indicator show "hot" overheat or continuously work over 2 mins. It'll be unlocked automatically after 18 mins rest.

DE: Wenn die Anzeige "hot" anzeigt, bedeutet dies, dass das System überhitzt ist oder 2 Minuten lang ununterbrochen gearbeitet hat. Nach 2 Minuten vollem Betrieb muss das System mindestens 18 Minuten abkühlen.

NL: Als de indicator "hot" aangeeft, betekent dit dat het systeem oververhit is of continu gewerkt heeft gedurende 2 minuten. Na 2 minuten voluit gewerkt te hebben moet het systeem minimaal 18 min afkoelen.

6. Error codes

Error code	Instruction / Anweisung / Instructie	Process method / Lösung / Oplossing
E05	Anti collision / Antikollisions / Anti botsing	Indicator light off / Kontrollleuchte aus / Indicatorlampje uit
E08	Desk tilt or control box shake Kippen Sie den Schreibtisch oder schütteln Sie die Steuerbox Bureau kantelen of schudden van de schakelkast	Fix control box Bringen Sie den Schaltkasten an Bevestig de schakelkast

7. Specifications

Input	100V/230V AC	Frame size	1100*520*59.5mm
Load Capacity:	80kg	Frame height	720-1170mm
Noice:	<52dB	Operation	0~40°C
Max.Speed:	25mm/s	Duty Cycle:	Max. 2 min. on / 18 min off

Settings | Instellingen | Einstellungen | error codes [single motor]

Memory position	Press "S", indicator show "S-", meanwhile "-" flicker, at the same time touch "1-4" button, reserve this position to button "1-4"	
Timer	1: Press "1" & "3" together 2: Press "▲" or "▼" to set the time. The timer can be set with 0,5 hours	
Lock & Unlock	Lock: S+"▲"; Unlock : S+"▼"	
Unit conversion (Cm→Inch or Inch →Cm)	Step 1: Long press the "S" key until show: "S-1"; Step 2: Again press the "S", then it show "0" or "1" (Current in use unit) Step 3: Press "▲" or "▼" to adjust the unit from "0" →"1" or "1"→"0" Step 4: Press "S" Save	
Upper and lower limit	Lower limit of the value below 100, press the "▲" + "▼" keys, listen to the buzzer Upper limit is above 100, press the "▲" + "▼" keys, listen to the buzzer	
Sensitivity adjustment	Step 1: Long press the "S" key until show: "S-1"; Step 2: Press "▲" Show : "S-2" Step 3: Touch "S" the hand display show the current sensitivity level;The default is level 4 Step 4: Press "▲" or "▼" to adjust the sensitivity level , from 1 ~8. Step 5: Press "S" Save	
Restart (RST) or (ASR)	Press and hold "▼", until display show lowest height and shows RST. Then press "▼" again. The desk will go up about 5mm. RST finished.	
Error Code	Status	Handle method
E01	The main supply voltage exceeds 45V	Check the main power supply
E02	The height deviation between the spindle is more than 1cm	Reinitialization
E04	Hand controller connection or communication error	Check the manual controller wire
E05	Distress stop display	Restart after power failure
E06	Main power failed to start, lower than 20V	Replace the main power supply, or check the main power cable
E07	Protection when the main power supply is running, lower than 20V	Connect the electricity again
E08	The desktop is tilted when running	Restart after power failure
HOT	The system overheats or works continuously for more than 2 minutes	Wait for an 18-minute rest
E11	Motor unconnected	Check the connection
E12	Motor current sampling channel error	Replacement panel
E13	Motor phase missing, phase line disconnected	Check whether the motor is improperly connected
E14	Motor hall error, or hall line disconnected	Check the hall signal, or change the cable
E15	Motor internal short circuit	Replace the motor
E16	Motor block rotation	Reinitialization
E17	Motor is running in the wrong direction	Replace the motor wire
E18	Motor overload	Reduce Load